



Perfect Appearance    Excellent Performance  
精 于 静                      精 于 动

# T28 Trojan

*(NEW 800mm Series V2)*

## OPERATING MANUAL



**Please visit both our Facebook fanpage and our homepage for updated product information**

# WARNING!

 **WARNING:** Read the ENTIRE instruction manual to become familiar with the features of the product before operating. Failure to operate the product correctly can result in damage to the product, personal property and cause serious injury.

This is a sophisticated hobby product and NOT a toy. It must be operated with caution and common sense and requires some basic mechanical ability. Failure to operate this Product in a safe and responsible manner could result in injury or damage to the product or other property. This product is not intended for use by children without direct adult supervision.

This manual contains instructions for safety, operation and maintenance. It is essential to read and follow all the instructions and warnings in this manual prior to assembly, setup, or use, in order to operate correctly and avoid damage or serious injury.

## Safety Precautions and Warnings

As the user of this product, you are solely responsible for operating in a manner that does not endanger yourself and others or result in damage to the product or the property of others. This model is controlled by a radio signal subject to interference from many sources outside your control. This interference can cause momentary loss of control so it is advisable to always keep a safe distance in all directions around your model, as this margin will help avoid collisions or injury.

Age Recommendation: Not for children under 14 years. This is not a toy.

- Never operate your model with low transmitter batteries.
- Always operate your model in an open area away from cars, traffic or people.
- Avoid operating your model in the street where injury or damage can occur.
- Never operate the model in the street or in populated areas for any reason.
- Carefully follow the directions and warnings for this and any optional support equipment (chargers, rechargeable battery packs, etc.) you use.
- Keep all chemicals, small parts and anything electrical out of the reach of children.
- Moisture causes damage to electronics. Avoid water exposure to all equipment not specifically designed and protected for this purpose.
- Never lick or place any portion of your model in your mouth as it could cause serious injury or even death.

## **FMS MODEL Friendly Reminder**



Thank you for purchasing a FMS MODEL product. Our goal is to provide high quality products and offer great customer service. If you have any problems with your product or want to offer suggestions for improvements (such as plane design, packaging, building instructions, etc.) please feel free to contact us at [info@fmsmodel.com](mailto:info@fmsmodel.com)

## **Table of contents**

<b>Kit contents</b> .....	<b>1</b>
<b>The spare parts list</b> .....	<b>1</b>
Spare parts list content	
The illustration of the spare parts	
<b>Kit Inspection</b> .....	<b>3</b>
<b>Charging the Flight Battery</b> .....	<b>3</b>
<b>Low Voltage Cutoff</b> .....	<b>6</b>
<b>Assemble the plane</b> .....	<b>6</b>
Install the control horns	
Mount the main wing	
Install the horizontal stabilizer	
Install the front landing gear	
Install the main landing gear	
The receiver connection	
The battery position	
Disassemble the motor	
<b>Get your model ready to fly</b> .....	<b>11</b>
The transmitter and model setup	
Important ESC and plane information	
Check the control throws	
Check the motor rotating direction	
Install the propeller set	
Check the C.G. (Center of Gravity)	
Flight control	
<b>Before the model flying</b> .....	<b>19</b>
Find a suitable flying site	
Perform the range check of your plane	
Monitor your flight time	
<b>Flying course</b> .....	<b>20</b>
Take off	
Flying	
Landing	
Maintenance	
<b>Troubleshooting</b> .....	<b>21</b>
<b>AMA</b> .....	<b>22</b>

## *Kit contents*



### **Kit contents**

1. The fuselage assembly (With the motor, the canopy, the electronic parts, ESC)
2. Main wing (With two aileron servos installed)
3. Horizontal stabilizer with the elevator
4. Landing gear set
5. Propeller and spinner
6. Spare parts bag and the oil tanks

## *The spare parts list*

Replacement parts for the FMS T28 Trojan are available using the order numbers in the Spare parts list that follows. The fastest, most economical service can be provided by your hobby dealer or mail-order company.

### **Spare parts list content**

Spare parts list content

- PA 101 **Red/Grey** Fuselage (With all the plastic parts and the linkage rods installed)
- PA 102 **Red/Grey** Main wing set (With the control horn in stored)
- PA 103 **Red/Grey** Horizontal stabilizer (With the joiner installed)
- PA 104 **Red/Grey** Canopy (With the foam cockpit and the plastic canopy, pilot included )
- PA 105 **Red/Grey** Spinner (With the hub)
- PA 106 Propeller (7\*6)

- PA 107 Cowl
- PA 108 Main landing gear set
- PA 109 Front landing gear set
- PA 110 Linkage rod (With the clevis and securing ring)
- PA 111 Motor mount
- PA 112 Decal sheet
- FMS-Motor-2408-KV1550
- FMS-ESC-20A
- FMS-Servo-9g-Positive
- FMS-Battery-7. 4V 1000mah 15C

Note: The item# with the Livery mark means the parts are special for the different schemes.

**The illustration of the spare parts**

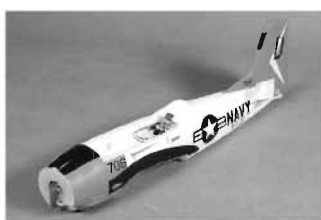

**PA 101**

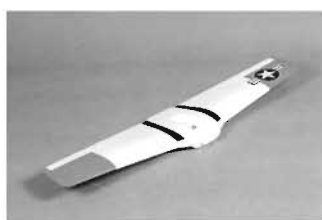

**PA 102**

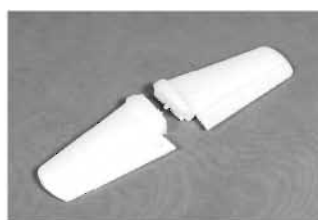

**PA 103**



**PA 104**

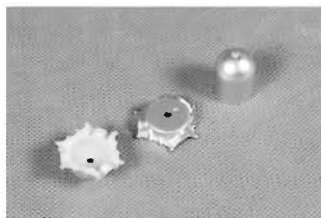

**PA 105**



**PA 106**



**PA 107**



**PA 108**



**PA 109**



**PA 110**



**PA 111**



**PA 112**



FMS-Motor-2408-KV1550



FMS-ESC-20A



FMS-Servo-9g-Positive



FMS-Battery-7. 4V 1000mah



## *Kit inspection*

Before starting to build, inspect the parts to make sure they are acceptable quality. If any parts are missing or are not in good shape or acceptable quality, or if you need assistance with setup and assembly, please feel free to contact FMSteam. Please write down the name of the parts when you are reporting defective or missing of them.

FMSteam Product Support

ADDRESS: 3/F, Building B, 3rd Industry Zone, Matigang, Dalingshan Town, Dongguan City, P.R.C

Ph: 0086-769-86976655

## *Charging the Flight Battery*

The Battery Charger included with your aircraft is designed to safely charge the Li-Po battery, **Caution:** All instructions and warnings must be followed exactly. Mishandling of Li-Po batteries can result in fire, personal injury, or property damage.

### **Battery warning:**

By handling, charging or using the included Li-Po battery you assume all risks associated with lithium batteries.

If at any time the batteries begin to swell, or balloon, discontinue use immediately!

Charging or discharging a swelling or ballooning battery can result in fire.

Always store the batteries at room temperature in a dry area to extend the life of the battery. Always transport or temporarily store the battery in a temperature range of 40-120°F. Do not store battery or model in a car or in direct sunlight. If stored in a hot car, the battery can be damaged or even catch fire.

Never use a Ni-Mh charger. Failure to charge the battery with a compatible charger may cause fire resulting in personal injury and property damage.

Never discharge Li-Po cells to below 3V.

Never leave charging batteries unattended.

Never charge damaged batteries.

### **Charging the flight battery**

RTF kits come with a DC balancing charger. You must charge the battery with a Li-Po specific charger only (such as the included **BC-3S10** DC charger). When charging the battery, make certain the battery is on a heat-resistant surface, charge the battery before assembly of the airplane. Install the fully charged battery to perform control tests and binding.

### **BC-3S10 Balance Charger**

To correctly use the charger, please read the instructions before use.

## ***Charging the Flight Battery***

### ***Electrical Parameters***

<b>Parameter</b>	<b>Min</b>	<b>Type</b>	<b>Max</b>	<b>Unit</b>
Working Voltage	9	12	16	V
Input Power	15			W
Work Temperature	- 20		45	°C
Store Temperature	- 20		65	°C
Charging Stop Voltage	4.19	4.20	4.21	V
Charging Current			1000	mA
Balancing Current	150		200	mA
Activate Current	80		120	mA

## ***Charging the Flight Battery***

### ***Using Steps:***

1. Connect the charger to adapter with enough voltage and wattage, then the Power LED will turn on;
2. Connect 2S/3S battery pack to the corresponding balance port (**Do not connect two battery packs at the same time**), then the Charge LED will flicker (1Hz) and start charging.
3. When the Charge LED stops flickering, charging is complete, and the batteries can be unplugged.

### ***Charging Function Description***

1. If all voltage of the installed battery pack is higher than 4.18V, charging will not start and the charge LED will shine.
2. If the voltage of one battery or some batteries is lower than 0.7V, charging will not start. If the voltage of the first battery of a 3S battery pack is lower than 0.7V, the charger will charge the battery pack as if it was a 2S battery pack.
3. If the voltage of one battery or some batteries is lower than 2.8V, the charger will activate the battery pack with a small current. If the voltage can't be increased above 2.8V after half an hour, the charger will judge the battery pack as bad. The charge LED will then flicker rapidly (0.5Hz), and charging will stop.

### ***Self Checking Function***

1. Charger will perform a self test before each charge. The charge LED will rapidly flicker (0.5Hz) if the charging function is abnormal;
2. Accuracy checking Function: Connect a fully charged 3S battery pack (all voltage at least 4.2V), the charge LED will flicker twice then shine always. This means that the accuracy is normal.

### ***Protection Function***

1. Reverse connection protection of input
2. Reverse connection protection of output
3. Short circuit protection of output
4. Over voltage protection of output

### ***Troubleshooting***

1. **Power LED does not shine** – Adapter isn't connected correctly. Please check the polarity and reconnect adapter.
2. **Charging abruptly stops and tries to restart constantly during charging** – Output power of the adapter is not sufficient, please replace the adapter.
3. **Charge LED does not shine** – Reconnect the battery pack; Check the voltage of batteries.
4. **Charge LED rapidly flickers** – Battery is bad or charging function is abnormal. Replace battery or contact technical support.



## Low voltage cut off (LVC)

When a Li-Po is discharged below 3V per cell, it will not hold a charge. The ESC protects the flight battery from over-discharge using Low Voltage Cutoff. Before the battery charge decreases too much, LVC removes power from motor in two ways: (1) Reduces power - ESC reduces motor power (recommended), (2) Hard cutoff - ESC instantly cuts motor power when the pre-set Low Voltage Protection Threshold value is reached. These settings can be changed using the ESC programming guide (available on-line).

## Assemble the plane

### Install the control horns

1. The control surface horns are stapled to the bag containing the horizontal stabilizer and do not discard them incidently. Connect the two stabilizers together make sure the notch for the elevator control horn located on the right side and we are facing the top of the stabilizer.
3. Secure the horn using the provided screws from the backplate side.  
**Note:** The longer screws for secure the horns always located on the leading side of the surface.

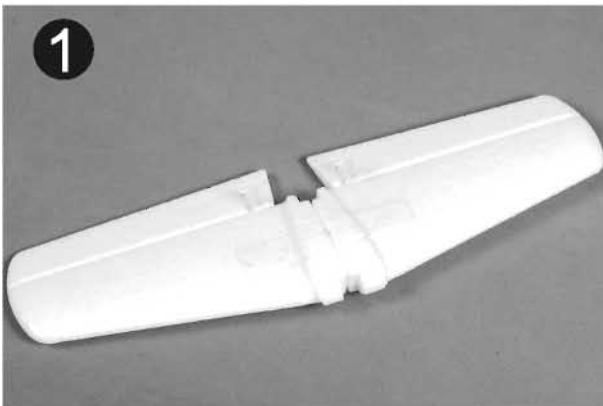

2. Attach the elevator control horn on the down side of the surface with the horn towards the hinge line.

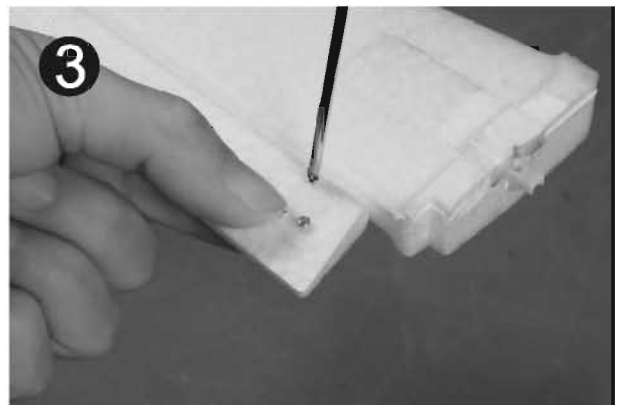

4. Make sure the screws firmly grabbed into the backplate.  
**Note:** Do not over tighten the screws, but make sure they are tight enough.

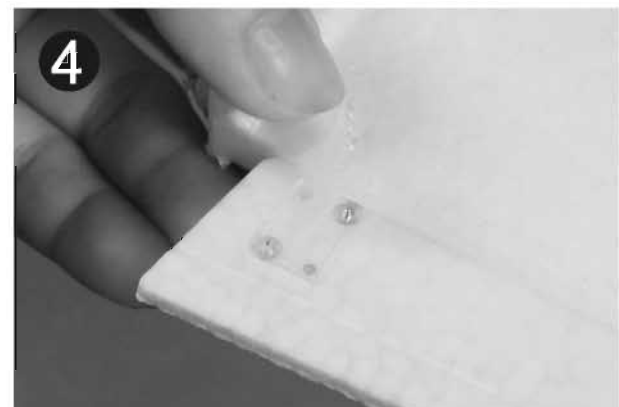

## Assemble the plane

5. Install the rudder horn on the port side(Left) of the fuselage.



6. Install the ailerons control horn on the bottom side of the main wing as the picture shows.

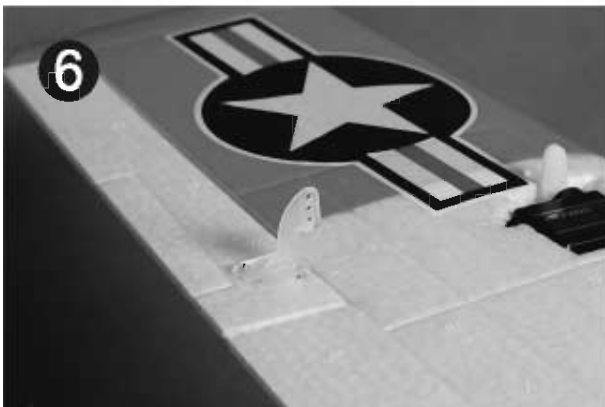

7. Waggle the control surface times to minimize the resistance of the foam hinges



### Connect the linkage rod

1. Thread the aileron leads from the wing mounting saddle bottom to the canopy hatch before mounting the main wing.



2. Slide the main wing into the groove on front of the main wing mounting saddle the first.



3. Be sure to pull the wire leads from the canopy hatch the same time to avoid any tangling to prevent the main wing from fully installation.

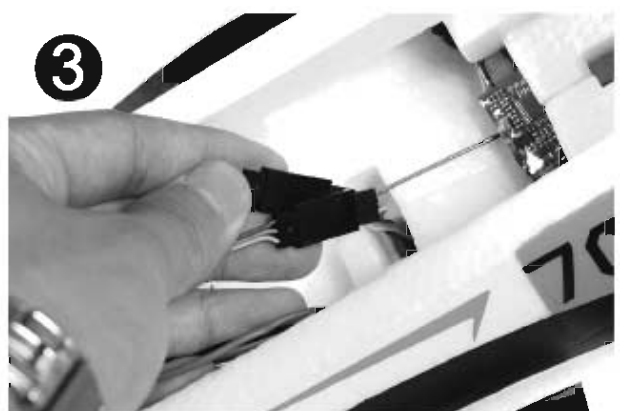

## Assemble the plane

4. Check to make sure the main wing aligns well with the wing root.

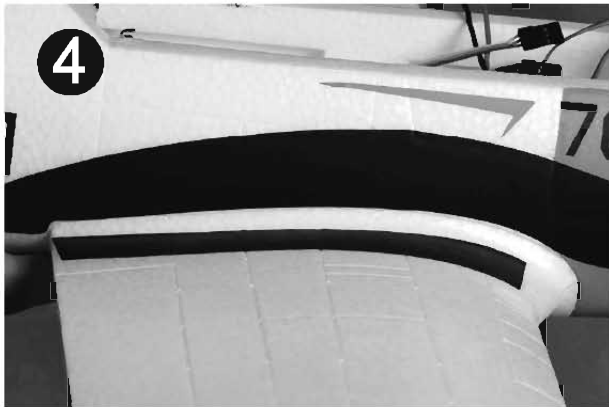

5. Secure the main wing using the provided screws. (Screws: PA2.6\*35 2PCS)

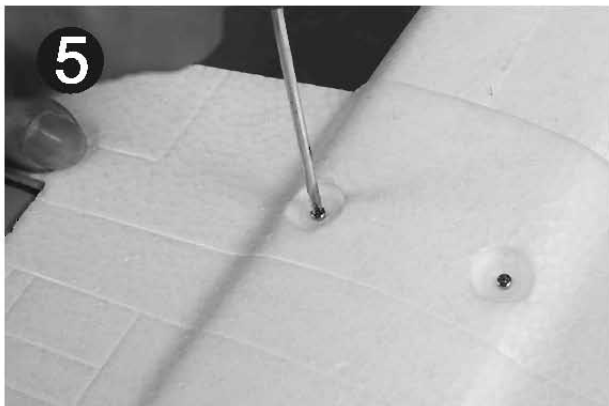

### Install the horizontal stabilizer

1. Apply glue on the combined side of the elevator.

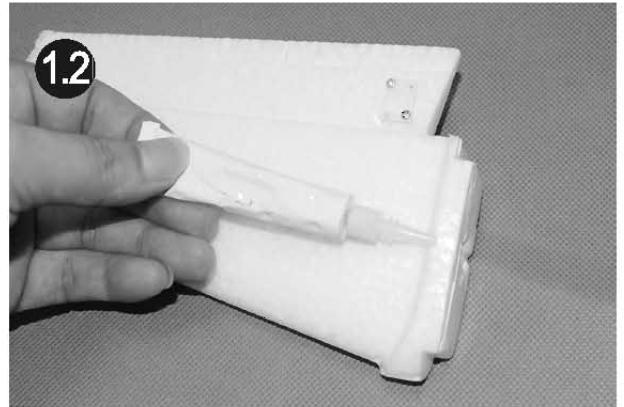
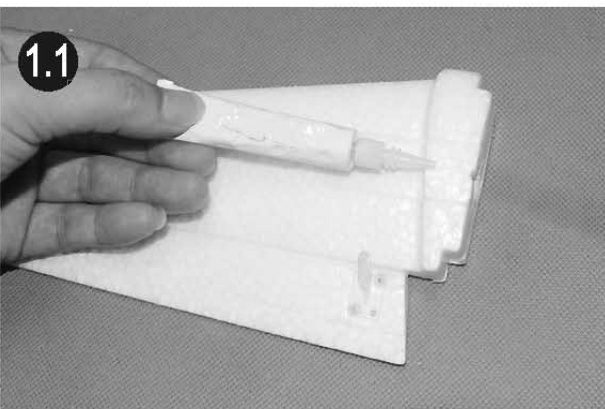

2. Install the elevator.



3. Check to make sure the stabilizer is standing fully vertical with the vertical fin. Adjust any misalignment before the glue dries thoroughly.

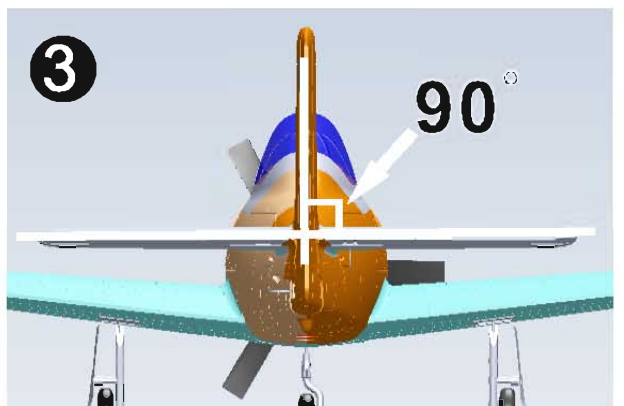

## Assemble the plane

### Install the front landing gear

1. Inset the front landing gear into the aluminum socket with the machined flat toward the grub screw side. Secure the front landing gear by tightening the grub screw against the flat with the provided screw.



### Install the main landing gear

1. Install the main landing gear by fitting the gear into the gear mounting base and slide the L end of gear into the hole as the picture shows.

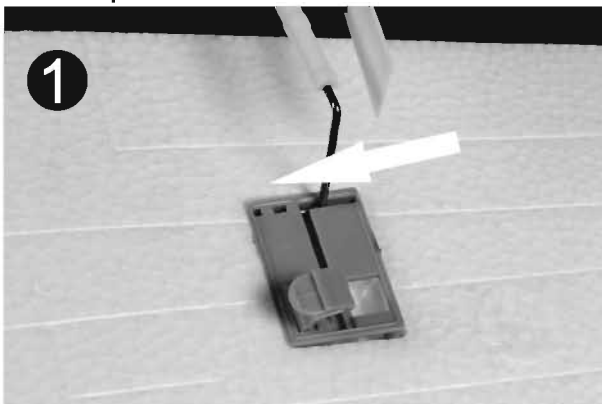

2. Rotate the gear strut and fully fit the strut into the slot.

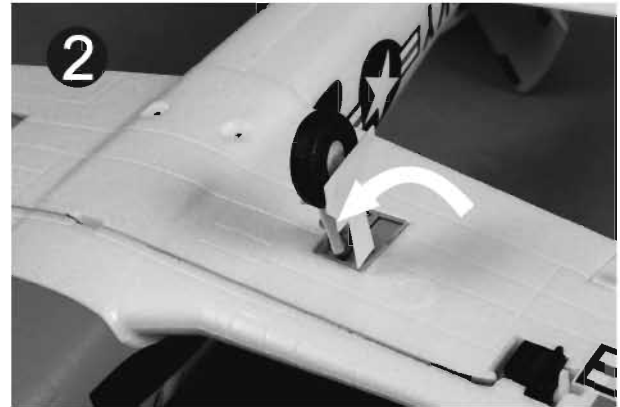

3. Make sure the fairing plate will toward the wing tip side of the plane. If not, you have to change the other strut.

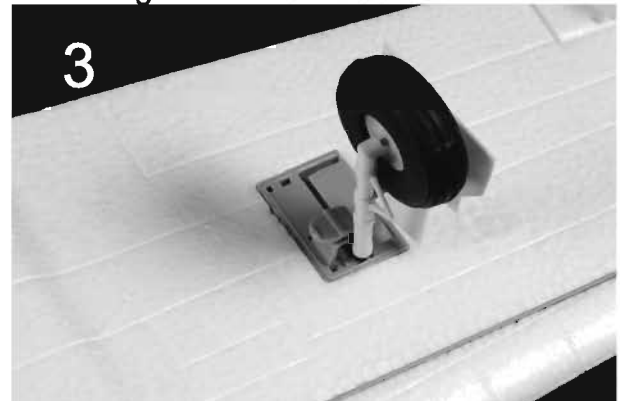

4. Snap in the button after the checking process completed, repeat the step for the other one strut installation.





## Assemble the plane

### The receiver connection

1. Connect the leads from the control surfaces and the ESC to the receiver,

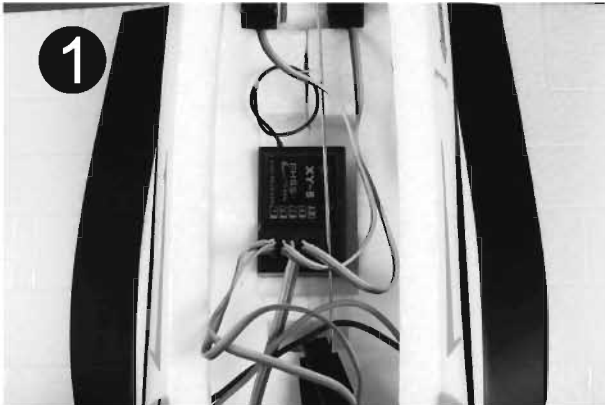

2. The servo leads connecting diagram.

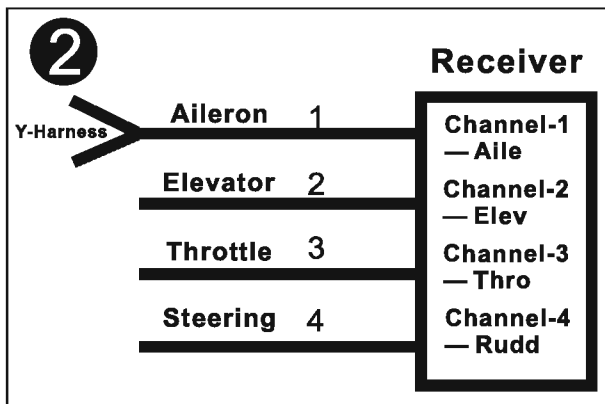

3. Attach the receiver to the hatch in front of the servo using the hook and loop tape.

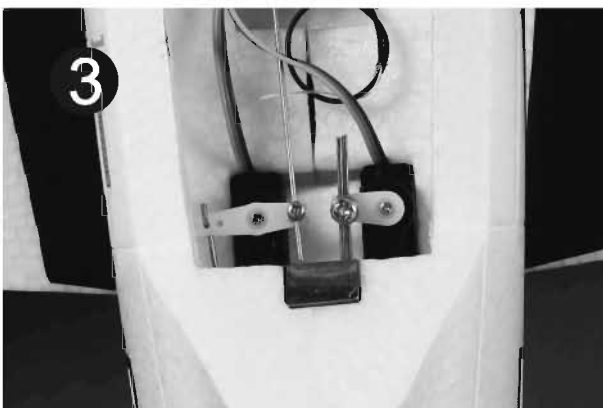

4. Tie the spare end of the servo leads together to make sure they will not interfere the moving path of the servo arm.

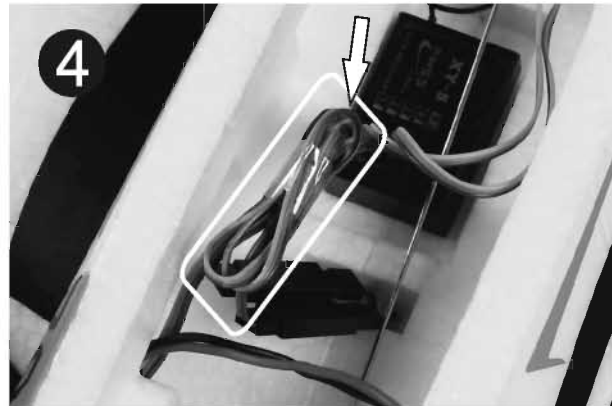

### Battery position

1. Slide the battery all the way into the battery hatch with the power supply cable toward the rear end of the plane.  
**Note:** You may need to relocate the battery position to achieve the correct CG for your model.



### Disassemble the motor

1. The two piece of screws on the motor base hold the motor into place, disassemble the motor using a screw driver to loosen the motor from the holes as the picture shows, the other one in the opposite side.



## Get your model ready to fly

### The transmitter and model setup

Before getting started, bind your receiver with your transmitter. Please refer to your **Transmitter Manual** for proper operation.

**CAUTION:** To prevent personal injury, DO NOT install the propeller assembly onto the motor shaft while testing the control surfaces. DO NOT arm the ESC and do not turn on the transmitter until the **Transmitter Manual** instructs you to do so.

**Tips:** Make sure all control sticks on your radio are in the neutral position (rudder, elevator, ailerons) and the throttle in the OFF position. Make sure both ailerons move up and down (travel) the same amount. This model tracks well when the left and right ailerons travel the same amount in response to the control stick.

1. Turn on your transmitter and power up your ESC, make sure the servo arms are fully vertical with the servo before hooking the linkage rods.

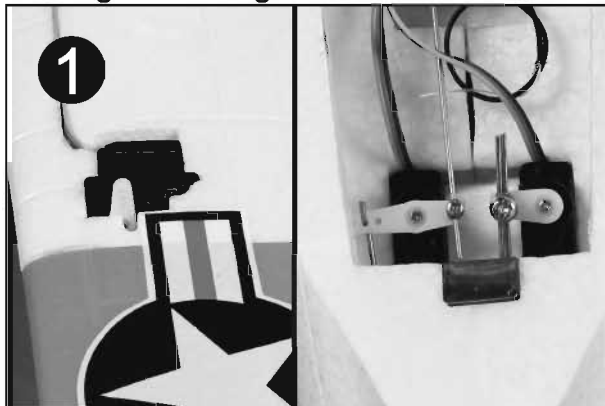

2. Put the Z-bend end of the linkage into the desired servo control horn hole. It is a tight fit and should allow the linkage to move just slightly within the hole to avoid binding up.

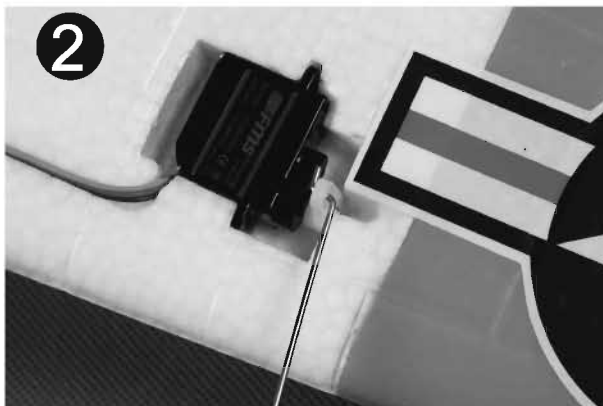

3. Snap the clevis into the surface control horn.



4. The provided piece of fuel tubing keeps the clevis closed during flight. Secure all the linkages the same way.



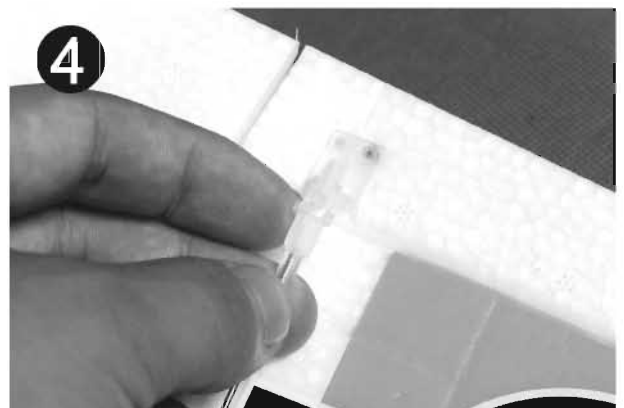





**Note:** Do not over slide the securing tube or it will impede the movement of the surface control horn.



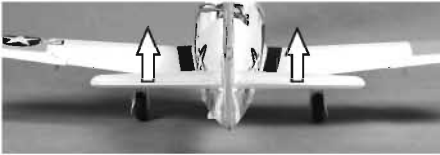
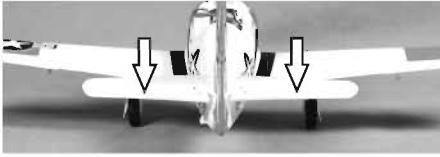

## Get your model ready to fly

5. Move the controls on the transmitter to make sure aircraft control surface move correctly. Or you have to program or switch the reverser on you transmitter to reverse corresponding control channel. See diagrams below.

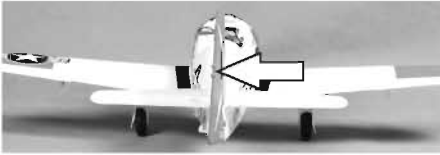
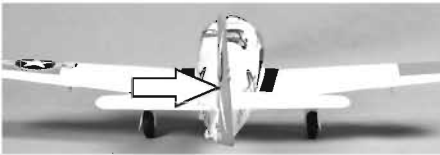
 <p>Bank Left</p>  <p>Bank Right</p>	 	<b>Aileron</b>
 <p>Climb</p>  <p>Descend</p>	 	<b>Elevator</b>
 <p>Yaw Left</p>  <p>Yaw Right</p>	 	<b>Steering Rudder</b>

## *Get your model ready to fly*

### **Important ESC and model information**

1. The ESC included with the **T28 Trojan** has a safe start. If the motor battery is connected to the ESC and the throttle stick is not in the low throttle or off position, the motor will not start until the throttle stick is moved to the low throttle or off position. Once the throttle stick is moved to the low throttle or off position, the motor will emit a series of beeps. Several beeps with the same tune means the ESC has detected the cells of the battery. The count of the beeps equals the cells of the battery. The motor is now armed and will start when the throttle is moved.
2. The motor and ESC come pre-connected and the motor rotation should be correct. If for any reason the motor is rotating in the wrong direction, simply reverse two of the three motor wires to change the direction of rotation.
3. The motor has an optional brake setting. The ESC comes with the brake switched off and we recommend that the **T28 Trojan** be flown with the brake off. However, the brake could be accidentally switched on if the motor battery is connected to the ESC while the throttle stick is set at full throttle. To switch the brake off, move the throttle stick to full throttle and plug in the motor battery. The motor will beep one time. Move the throttle stick to low throttle or the off position. The motor is ready to run and the brake will be switched off.
4. **Battery Selection and Installation.** We recommend the 7.4V 1000mAh 15C(1.9oz) Li-Po battery. If using another battery, the battery must be at least a 7.4V 1000mAh 15C battery. Your battery should be approximately the same capacity, dimension and weight as the 7.4V 1000mAh 15C Li-Po battery to fit in the fuselage without changing the center of gravity significantly.
5. The specification of the model list as follows:
  - **Material: Durable EPO**
  - **Wing Span: 800mm ( 31.5in )**
  - **Length: 670mm ( 26.3in )**
  - **Flying Weight: Around 470 g**
  - **Servo: 9g Servo x 4,**
  - **Landing Gear : Steerable Rear Landing Gear**
  - **Motor: KV 1550 Powerful Out runner Brushless Motor**
  - **ESC: 20A Brushless ESC**
  - **Propeller: 7\*6 3 Blade Propeller With Spinner**
  - **Battery: Li-Po 7.4V 1,000mAh 15C(54g/1.9oz)**
  - **Radio: 4Ch Radio Control**
  - **CG Position:45mm (From Leading Edge)**

## Get your model ready to fly

### Check the control throws

1. Make sure all servo arms are fully vertical. If not, adjust the servo arm by using the trim function on your radio. **Note:** For computerized transmitters, use the servo/channel sub-trim feature to make each servo arm fully vertical.
2. The standard hole settings for linkage connections are shown by the black arrows in the diagram below. You can move the linkage to different hole positions to increase control surface travel and increase the aerobatics of the airplane.

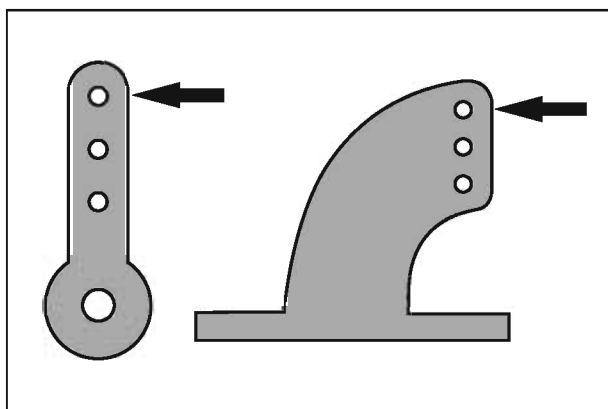

3. Align the control surface with the wing root by turning the clevis clockwise and counterclockwise on the linkage, carefully open the clevis fork and put the clevis pin in the desired hole of the control horn.  
**Note:** Please secure the clevis with provided piece of tube after the alignment of the surface is completed.

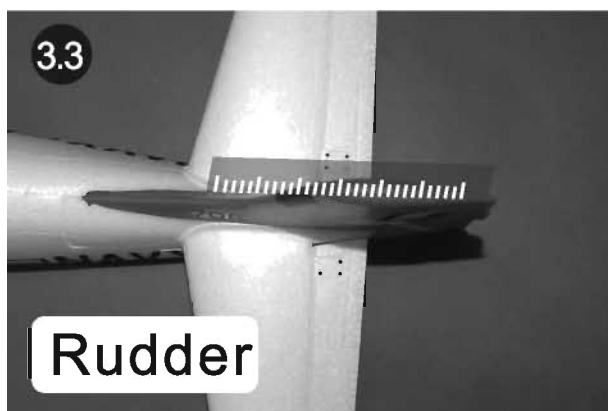
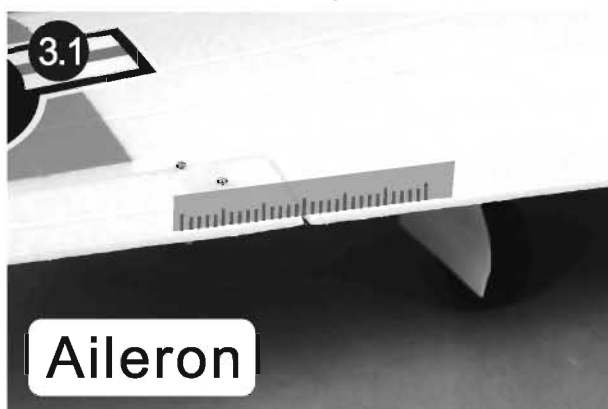

## Get your model ready to fly

The suggested control throw settings for **FMS MODEL** are as follows (Dual rate setting):

	High Rate	Low Rate
Elevator	10mm up/down	6mm up/down
Aileron	10mm up/down	6mm up/down
Rudder	12mm left/right	7mm left/right

**Tips:** At first flight, fly the model in low rate. The first time you use high rates, be sure to fly at low to medium speeds. High rates, as listed, are only for EXTREME maneuvering.

### Check the motor rotating direction

**Caution:** Do not install the propeller set to the motor while testing the rotating direction to avoid any body or property injury.

1. The motor should rotate clockwise when viewing the plane from the rear.



### Install the propeller set

**Caution:** Disconnect the battery from the ESC while installing the propeller to avoid any body or property injury.

1. Keyed the propeller hub back plate onto the motor shaft fully. The plate will mate with the hex nut on the shaft.



2. Install the propeller set to the motor shaft, the side with the maintenance mark faces the front of the plane.



3. Install the front part of the hub.

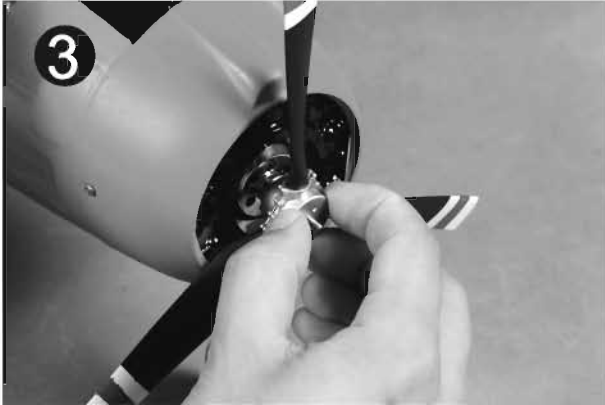

4. Hand tighten the spinner and make sure it's tight enough.



## Check the C.G. (Center of Gravity)

### Center of Gravity

When balancing your model, adjust the motor battery as necessary so the model is level or slightly nose down. This is the correct balance point for your model. After the first flights, the **CG** position can be adjusted for your personal preference.

1. The recommended Center of Gravity (**CG**) location for your model is **(45mm)** forward from the wing root leading edge of the main wing (as shown) with the battery pack installed. Mark the location of the **CG** on top of the wing.
2. When balancing your model, support the plane at the marks made on the top side of the main wing with your fingers or a commercially available balancing stand. This is the correct balance point for your model. Make sure the model is assembled and ready for flight before balancing.





## Fight control

For smooth control of your aircraft, always make small control moves. All directions are described as if you were sitting in the aircraft.

### Tips:

1. Flying faster and slower: When your aircraft is stable in the air, push the throttle stick up to make the aircraft go faster, and pull the throttle stick back to slow down. The aircraft will climb when the throttle is increased.
2. Bank right and left: Move the aileron stick right to make the aircraft bank right and move the aileron stick left to bank left.
3. Elevator up and down: Push the elevator stick forward to make the aircraft go down and pull the elevator stick back to go up.
4. Yaw right and left: Move the rudder stick right to make the aircraft go right and move the rudder stick left to go left (as if you are seated in the cockpit).



**Throttle up to move faster**

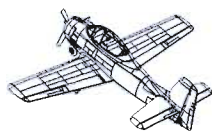

**Bank left**

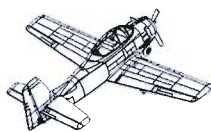

**Bank right**

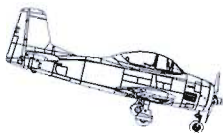

**Climb**

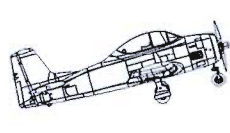

**Descent**



**Yaw left**



**Yaw right**

## ***Before the model flying***

### **Find a suitable flying site**

Find a flying site clear of buildings, trees, power lines and other obstructions. Until you know how much area will be required and have mastered flying your plane in confined spaces, choose a site which is at least the size of two to three football fields – a flying field specifically for R/C planes is best. Never fly near people– especially children who can wander unpredictably.

### **Perform the range check of your plane**

As a precaution, an operational ground range test should be performed before the first flight each time you go out. Performing a range test is a good way to detect problems that could cause loss of control such as low batteries, defective or damaged radio components, or radio interference. This usually requires an assistant and should be done at the actual flying site you will be using.

First turn on the transmitter, then install a fully-charged battery into the fuselage. Connect the battery and install the hatch.

Remember, use care not to bump the throttle stick, otherwise, the propeller / fan will turn and possibly cause damage or injury.

**Note:** Please refer to your Transmitter Manual that came with your radio control system to perform a ground range check. If the controls are not working correctly or if anything seems wrong, do not fly the model until you correct the problem. Make certain all the servo wires are securely connected to the receiver and the transmitter batteries have a good connection.

### **Monitor your flight time**

Monitor and limit your flight time using a timer (such as one on a wrist watch or in your transmitter if available). When the batteries are getting low you will usually notice a performance drop before the ESC cuts off motor power, so when the plane starts flying slower you should land. Often (but not always) power can be briefly restored after the motor cuts off by holding the throttle stick all the way down for a few seconds.

To avoid an unexpected dead-stick landing on your first flight, set your timer to a conservative 4 minutes. When your alarm sounds you should land right away.

## *Flying course*

### **Take off**

While applying power slowly steer to keep the model straight, the model should accelerate quickly. As the model gains flight speed, you will want to climb at a steady and even rate. The **P47 Thunderbolt** will climb out at a nice angle of attack (AOA).

### **Flying**

Always choose a wide-open space for flying your plane. It is ideal for you to fly at a sanctioned flying field. If you are not flying at an approved site, always avoid flying near houses, trees, wires and buildings. You should also be careful to avoid flying in areas where there are many people, such as busy parks, schoolyards, or soccer fields. Consult laws and ordinances before choosing a location to fly your aircraft. After takeoff, gain some altitude. Climb to a safe altitude and begin to trim the model till it's tracks well through all aspects of flight, including high speed passes, inverted flight, loops, and point rolls.

### **Landing**

Land the model when you hear the motor pulsing (LVC) or if you notice a reduction in power. If using a transmitter with a timer, set the timer so you have enough flight time to make several landing approaches.

Recharge the battery and repair the model as needed. The model's three point landing gear allows the model to land on hard surfaces. Align model directly into the wind and fly down to the ground. Fly the airplane down to the ground using 1/4-1/3 throttle to keep enough energy for proper flare. Before the model touches down, always fully decrease the throttle to avoid damaging the propeller or other components. The key to a great landing is to manage the power and elevator all the way to the ground and set down lightly on the main landing gear. After a few flights you will find the model can be set down lightly on the mains and you can hold the tail wheel off balancing the model on the mains till it slows and gently settles the tail.

### **Maintenance**

Repairs to the foam should be made with foam safe adhesives such as hot glue, foam safe CA, and 5 min epoxy. When parts are not repairable, see the Spare Parts List for ordering by item number.

Always check to make sure all screws on the aircraft are tightened. Pay special attention to make sure the bullet of the rotor adaptor is firmly in place before every flight.

## Troubleshooting

Problem	Possible Cause	Solution
Aircraft will not respond to the throttle but responds to other controls.	<ul style="list-style-type: none"> <li>- ESC is not armed.</li> <li>- Throttle channel is reversed.</li> </ul>	<ul style="list-style-type: none"> <li>- Lower throttle stick and throttle trim to lowest settings.</li> <li>- Reverse throttle channel on transmitter.</li> </ul>
Extra propeller noise or extra Vibration.	<ul style="list-style-type: none"> <li>- Damaged spinner, propeller, motor, or motor mount.</li> <li>- Loose propeller and spinner parts.</li> <li>- Propellor installed backwards.</li> </ul>	<ul style="list-style-type: none"> <li>- Replace damaged parts.</li> <li>- Tighten parts for propeller adapter, propeller and spinner.</li> </ul>
Reduced flight time or aircraft underpowered.	<ul style="list-style-type: none"> <li>- Flight battery charge is low.</li> <li>- Propeller installed backward.</li> <li>- Flight battery damaged.</li> </ul>	<ul style="list-style-type: none"> <li>- Remove and install propeller correctly.</li> <li>- Completely recharge flight battery.</li> <li>- Replace flight battery and obey flight battery instructions.</li> </ul>
Control surface does not move, or is slow to respond to control inputs.	<ul style="list-style-type: none"> <li>- Control surface, control horn, linkage or servo damage.</li> <li>- Wire damaged or connections loose.</li> </ul>	<ul style="list-style-type: none"> <li>- Replace or repair damaged parts and adjust controls.</li> <li>- Do a check of connections for loose wiring.</li> </ul>
Controls reversed.	Channels are reversed in the transmitter.	Do the Control Direction Test and adjust controls for aircraft and transmitter.
<ul style="list-style-type: none"> <li>- Motor loses power.</li> <li>- Motor power pulses then motor loses power.</li> </ul>	<ul style="list-style-type: none"> <li>- Damage to motor, or battery.</li> <li>- Loss of power to aircraft.</li> <li>- ESC uses default soft Low Voltage Cutoff(LVC).</li> </ul>	<ul style="list-style-type: none"> <li>- Do a check of batteries, transmitter, receiver, ESC, motor and wiring for damage (replace as needed).</li> <li>- Land aircraft immediately and Recharge flight battery.</li> </ul>
LED on receiver flashes slowly.	Power loss to receiver.	<ul style="list-style-type: none"> <li>- Check connection from ESC to receiver.</li> <li>- Check servos for damage.</li> <li>- Check linkages for binding.</li> </ul>

# AMA

If you are not already a member of the AMA, please join, The AMA is the governing body of model aviation and membership provided liability insurance coverage, protects modelers' rights and interests and is required to fly at most R/C sites.

## **Academy of Model Aeronautics**

5151 East Memorial Drive

Muncie, IN 47302-9252

Ph.(800)435-9262

Fax(765)741-0057

Or via the Internet at: <http://www.modelaircraft.org>



## **Academy of Model Aeronautics National Model Aircraft Safety Code Effective January 1, 2011**

- A. GENERAL:** A model aircraft is a non-human-carrying aircraft capable of sustained flight in the atmosphere. It may not exceed limitations of this code and is intended exclusively for sport, recreation and/or competition.  
All model flights must be conducted in accordance with this safety code and any additional rules specific to the flying site.
1. Model aircraft will not be flown:
    - (a) In a careless or reckless manner.
    - (b) At a location where model aircraft activities are prohibited.
  2. Model aircraft pilots will:
    - (a) Yield the right of way to all man carrying aircraft.
    - (b) See and avoid all aircraft and a spotter must be used when appropriate.  
(AMA Document #540-D-See and Avoid Guidance.)
    - (c) Not fly higher than approximately 400 feet above ground level within three (3) miles of an airport, without notifying the airport operator.
    - (d) Not interfere with operations and traffic patterns at any airport, heliport or seaplane base except where there is a mixed use agreement.
    - (e) Ensure the aircraft is identified with the name and address or AMA number of the owner on the inside or affixed to the outside of the model aircraft.  
(This does not apply to model aircraft flown indoors).
    - (f) Not operate aircraft with metal-blade propellers or with gaseous boosts except for helicopters operated under the provisions of AMA Document #555.
    - (g) Not operate model aircraft while under the influence of alcohol or while using any drug which could adversely affect the pilot's ability to safely control the model.
    - (h) Not operate model aircraft carrying pyrotechnic devices which explode or burn, or any device which propels a projectile or drops any object that creates a hazard to persons or property.

## AMA

### Exceptions:

- ◆ Free Flight fuses or devices that burn producing smoke and are securely attached to the model aircraft during flight.
  - ◆ Officially designated AMA Air Show Teams (AST) are authorized to use devices and practices as defined within the Team AMA Program Document (AMA Document #718).
3. Model aircraft will not be flown in AMA sanctioned events, air shows or model demonstrations unless:
- (a) The aircraft, control system and pilot skills have successfully demonstrated all maneuvers intended or anticipated prior to the specific event.
  - (b) An inexperienced pilot is assisted by an experienced pilot.
4. When and where required by rule, helmets must be properly worn and fastened. They must be OSHA, DOT, ANSI, SNELL or NOCSAE approved or comply with comparable standards.

### B. RADIO CONTROL (RC)

1. All pilots shall avoid flying directly over unprotected people, vessels, vehicles or structures and shall avoid endangerment of life and property of others.
2. A successful radio equipment ground-range check in accordance with manufacturer's recommendations will be completed before the first flight of a new or repaired model aircraft.
3. RC model aircraft must use the radio-control frequencies currently allowed by the Federal Communications Commission (FCC). Only individuals properly licensed by the FCC are authorized to operate equipment on Amateur Band frequencies.
4. RC model aircraft will not operate within three (3) miles of any pre-existing flying site without a frequency-management agreement (AMA Documents #922-Testing for RF Interference; #923- Frequency Management Agreement)
5. With the exception of events flown under official AMA Competition Regulations, excluding takeoff and landing, no powered model may be flown outdoors closer than 25 feet to any individual, except for the pilot and the pilot's helper(s) located at the flight line.
6. Under no circumstances may a pilot or other person touch a model aircraft in flight while it is still under power, except to divert it from striking an individual. This does not apply to model aircraft flown indoors.
7. RC night flying requires a lighting system providing the pilot with a clear view of the model's attitude and orientation at all times.
8. The pilot of a RC model aircraft shall:
  - (a) Maintain control during the entire flight, maintaining visual contact without enhancement other than by corrective lenses prescribed for the pilot.
  - (b) Fly using the assistance of a camera or First-Person View (FPV) only in accordance with the procedures outlined in AMA Document #550.

### C. FREE FLIGHT

1. Must be at least 100 feet downwind of spectators and automobile parking when the model aircraft is launched.
2. Launch area must be clear of all individuals except mechanics, officials, and other fliers.
3. An effective device will be used to extinguish any fuse on the model aircraft after the fuse has completed its function.



